

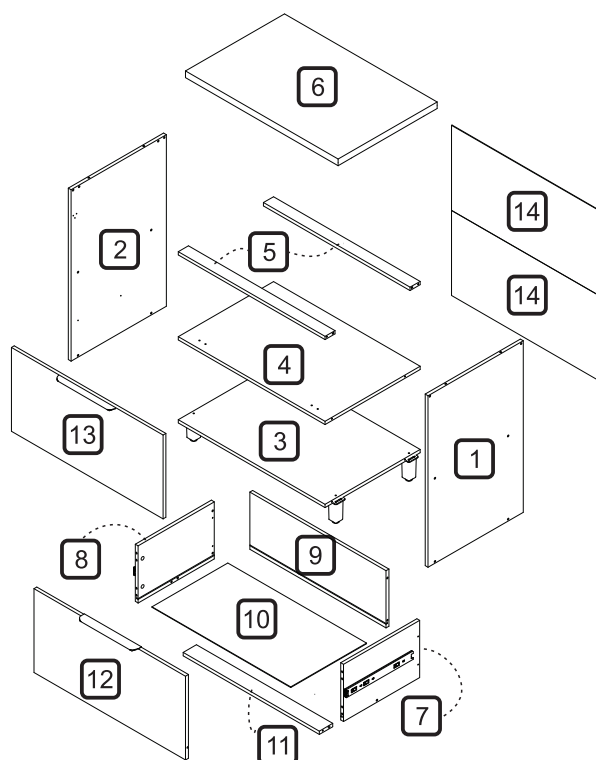

A marca da gestão florestal responsável  
FSC® C168299

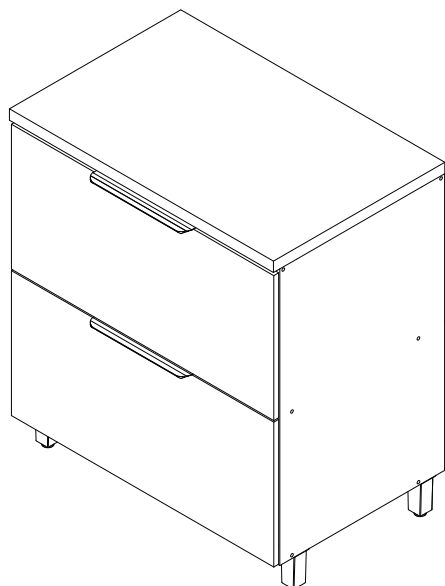

**DIMENSÕES DOS ESPAÇOS INTERNOS (MEDIDAS EM MILÍMETROS)**

DIMENSÕES MÁXIMAS DO PRODUTO MONTADO

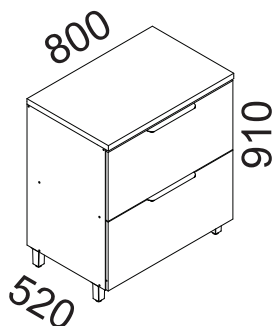



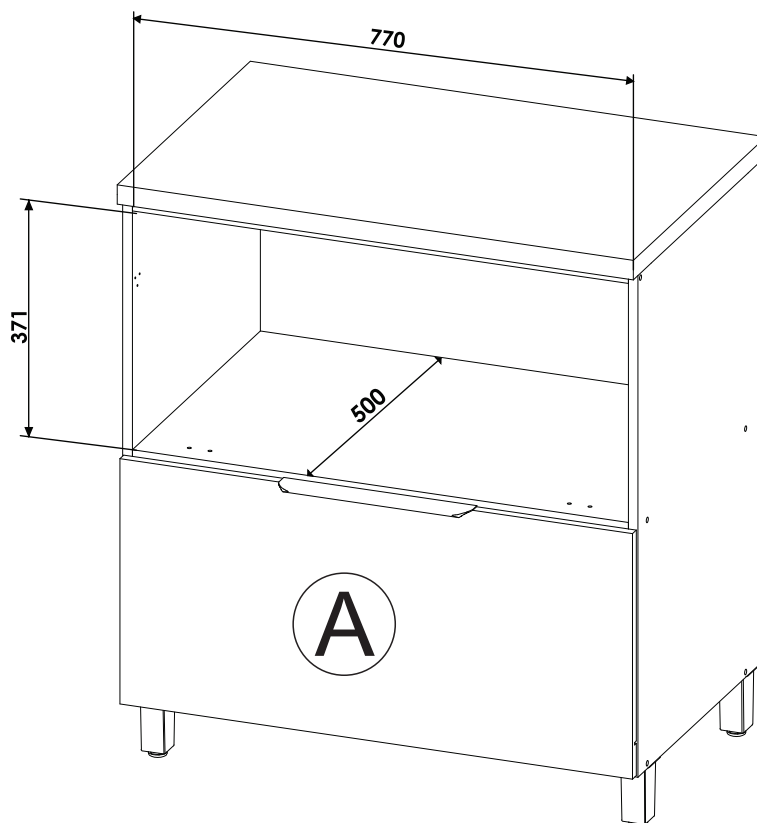

ESPAÇO INTERNO DAS GAVETAS  
(largura x altura x profundidade)

Ⓐ 715 x 240 x 385 mm

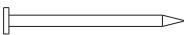
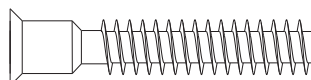
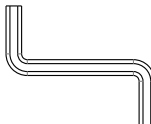
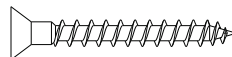

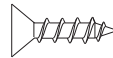
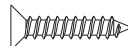
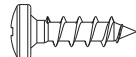
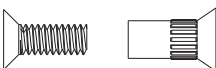
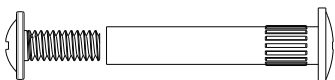
CÓDIGO	DESCRIÇÃO	QTDE	COMP	LARG	ESP
1	LATERAL DIREITA	1	780	500	15
2	LATERAL ESQUERDA	1	780	500	15
3	BASE	1	770	500	15
4	PRATELEIRA	1	770	500	15
5	TRAVESSA SUPERIOR	2	770	53	15
6	BANCADA	1	801	520	30
7	LATERAL GAVETA MAIOR DIR	1	400	260	15
8	LATERAL GAVETA MAIOR ESQ	1	400	260	15
9	TRASEIRO GAVETA MAIOR	1	715	260	15
10	FUNDO GAVETA	1	729	398	2.5
11	TRAVESSA GAVETA MAIOR	1	715	70	15
12	FRENTE GAVETA MAIOR	1	796	381	15
13	PORTA BASCULANTE	1	796	381	15
14	FUNDO TRASEIRO	2	795	387	2.5

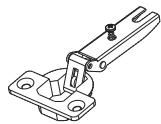
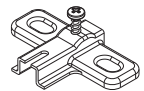
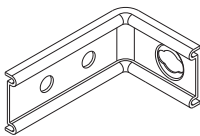
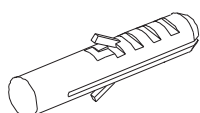
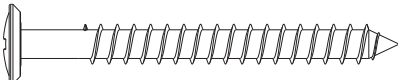
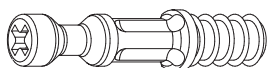
CÓDIGO/DESCRIÇÃO	QUANTIDADE	CÓDIGO/DESCRIÇÃO	QUANTIDADE
<b>A</b>  PREGO 10x10 COM CABEÇA	<b>35</b>	<b>B</b>  PARAFUSO 7x40mm CABEÇA CHATA	<b>14</b>
<b>C</b>  CHAVE ZETA	<b>1</b>	<b>D</b>  PARAFUSO 3,5x30mm CABEÇA CHATA	<b>6</b>
<b>E</b>  PARAFUSO 3,5x40mm CABEÇA CHATA	<b>4</b>	<b>F</b>  PARAFUSO 3,5x14mm CABEÇA CHATA	<b>12</b>
<b>G</b>  PARAFUSO 3x16mm CABEÇA CHATA	<b>4</b>	<b>H</b>  PARAFUSO 4x14mm CABEÇA PANELA	<b>16</b>
<b>I</b>  PARAFUSO DE UNIÃO 17mm	<b>5</b>	<b>J</b>  PARAFUSO UNIÃO DE MÓDULOS 28MM	<b>3</b>
<b>K</b>  CAVILHA 8x30mm	<b>18</b>	<b>L</b>  BATENTE DE SILICONE	<b>4</b>
<b>M</b>  DOBRADIÇA ALTA CANECO 35mm	<b>2</b>	<b>N</b>  CALÇO PARA DOBRADIÇA 35 mm - 5mm	<b>2</b>
<b>O</b>  CANTONEIRA METÁLICA PARA FIXAÇÃO NA PAREDE	<b>4</b>	<b>P</b>  BUCHA DE PAREDE DE 8mm	<b>4</b>
<b>Q</b>  PARAFUSO 5x50mm CABEÇA FLANGEADA	<b>8</b>	<b>R</b>  PARAFUSO MINIFIX	<b>5</b>